



# No lar

Kování pro celoskleněné dveře



# ÚVOD



Rádi bychom vám touto cestou představili nabídku kování Holar pro celoskleněné dveře a systémy.

V našem katalogu naleznete široký sortiment nerezového i křišťálového kování v různých povrchových úpravách, které vám umožní najít ideální řešení pro váš projekt.

Připravili jsme pro vás také užitečné informace a technické specifikace, které vám pomohou při výběru vhodných produktů.

Naše kování je ideální pro použití v komerčních i rezidenčních projektech, ať už se jedná o elegantní posuvné dveře, skleněné přičky nebo přírodní světlíky. Všechna kování lze dodat také v provedení na dveře nebo okna.

Ponořte se do světa moderního designu a funkčního kování Holar - těšíme se na spolupráci na Vašich projektech!



křišťálové  
sklo



povrchové  
úpravy



libovolné  
rozměry



zakázková  
výroba

## **výrobky Holar s přidanou hodnotou**



chráněná  
dílna



rodinná  
firma



český  
výrobek

## **naše hodnoty**

**MADLA:**



**Madlo Sofi**  
Crystal Glass ø30, ø25 mm

str. 4



**Madlo Irma**  
Crystal Glass ø35, ø25 mm

str. 5



**Madlo F1**  
Crystal Glass/buk  
a nerez/buk

str. 6



**Madlo W1 a W2**  
buk

str. 7



**Madlo F1**  
ø 20, 20x20 mm

str. 8



**Madlo U**  
ø 20, 20x20 mm

str. 9



**Madlo F1 a U**  
s muší a záslepkou

str. 10-11



**Madlo F1, F2, F3 a F4**

str. 12



**Madlo B, C, G**

str. 13



**Madlo U 350 - 1000 mm**

str. 14

**ÚCHYTKY:**



**Vali**  
Crystal Glass

str. 15



**Jula**  
Crystal Glass

str. 16



**Galina**  
Crystal Glass

str. 17



**Sascha**  
Crystal Glass

str. 18



**Lena**  
Crystal Glass

str. 19



**Rita**  
Crystal Glass

str. 20



**Judy**  
Crystal Glass

str. 21

**KLIKY, KOULE, ZÁMKY A KOVÁNÍ:**



**Zámky, závěsy a vložky**  
k zámkům na sklo

str. 22



**Kliky Crystal Glass,**  
k zámkům na sklo

str. 23



**Kliky nerez, se dřevem,**  
raffirem k zámkům na sklo

str. 24-26

# Madlo Sofi

madla z křišťálového skla



## Madlo Sofi D30 nebo D25 mm

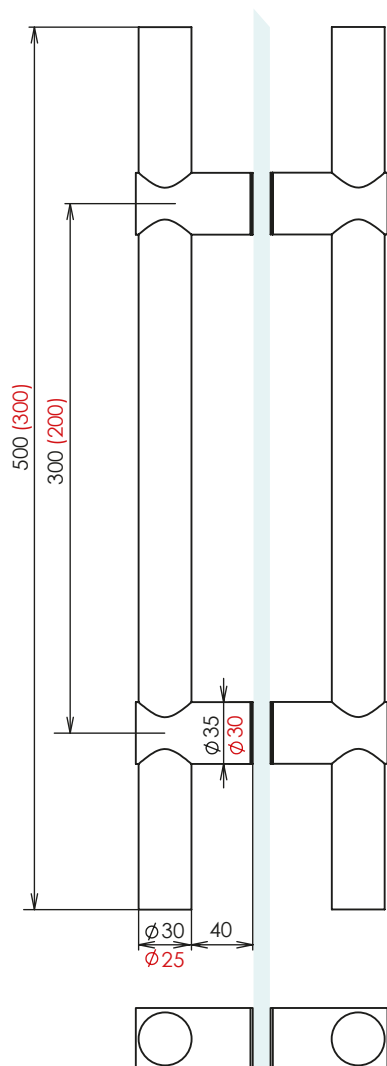

## Povrchové úpravy:



## Příprava skla:

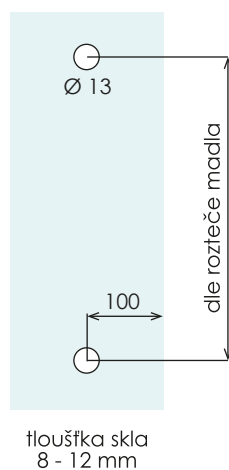

## Varianty:

| Průměr | Rozteč | Celková délka |
|--------|--------|---------------|
| Ø 30   | 300    | 500           |
| Ø 30   | 200    | 300           |
| Ø 25   | 300    | 500           |
| Ø 25   | 200    | 300           |

rozměry v mm  
Jiné rozměry nebo povrchové úpravy na dotaz.



madla z křišťálového skla

# Madlo Irma



## Madlo Irma 35x35 nebo 25x25 mm

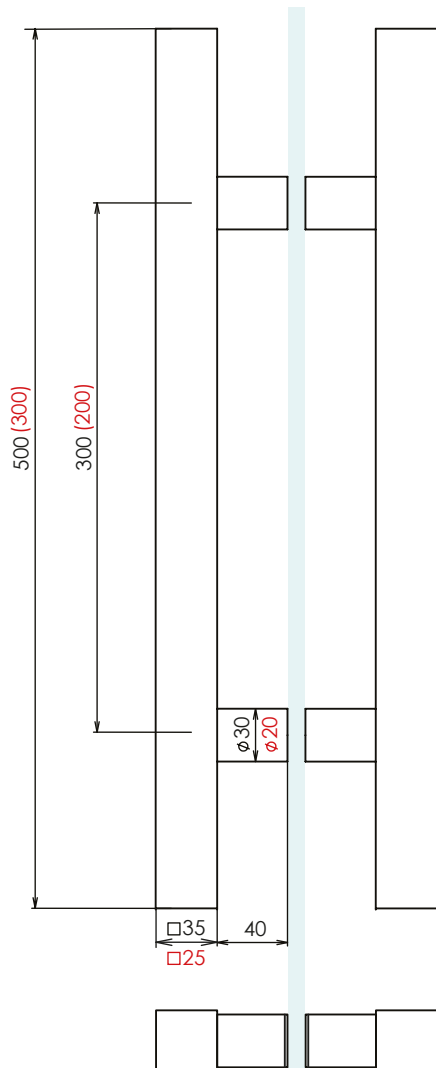

## Povrchové úpravy:



## Příprava skla:

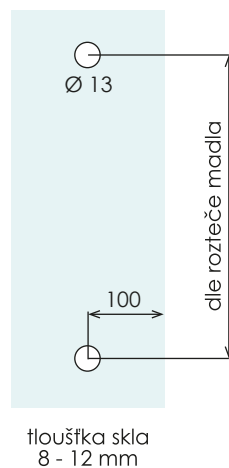

## Varianty:

| Průměr  | Rozteč | Celková délka |
|---------|--------|---------------|
| 35 x 35 | 300    | 500           |
| 35 x 35 | 200    | 300           |
| 25 x 25 | 300    | 500           |
| 25 x 25 | 200    | 300           |

rozměry v mm  
Jiné rozměry nebo povrchové úpravy na dotaz.

# Madlo F1 kov/sklo a kov/dřevo

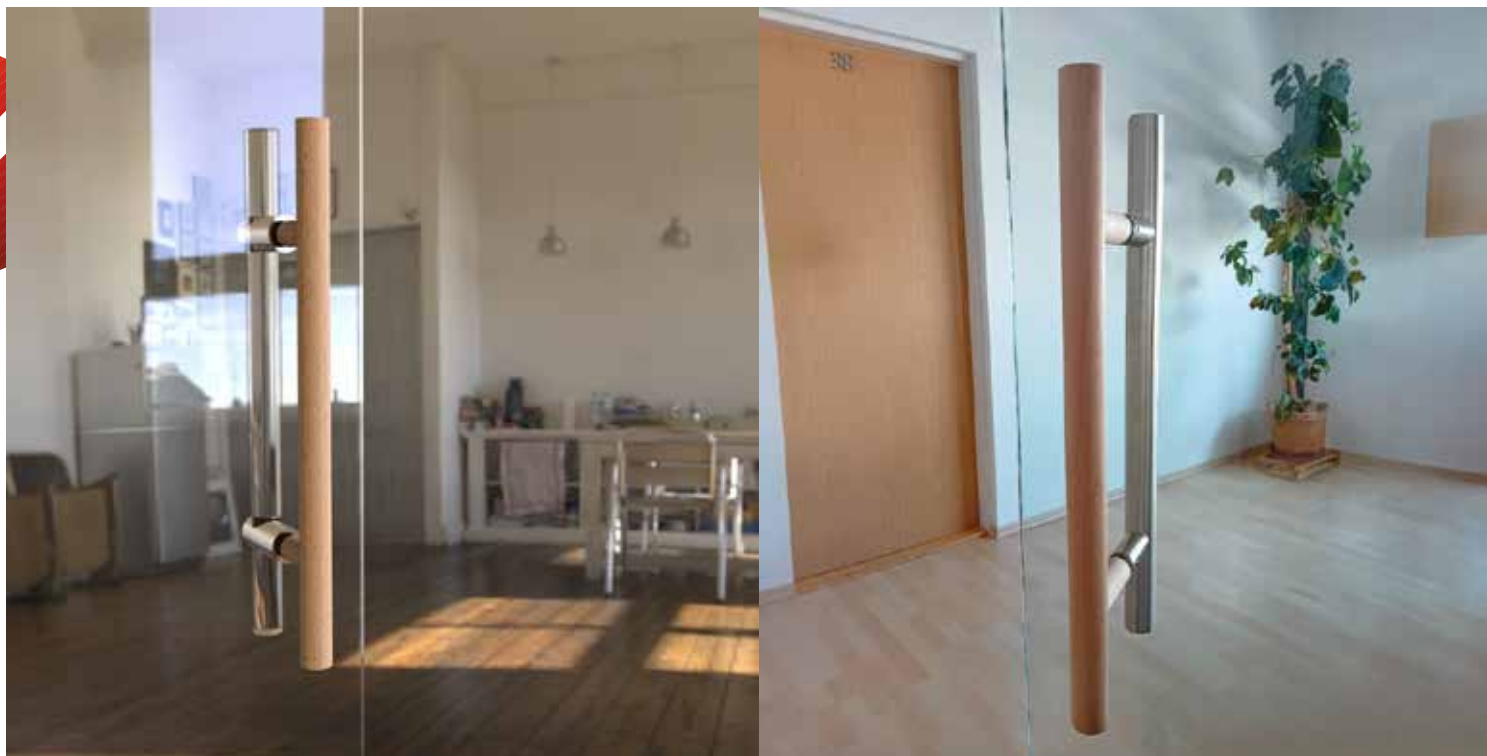

Madlo Sofi D30 mm / Madlo F1 (buk)

Povrchové úpravy:

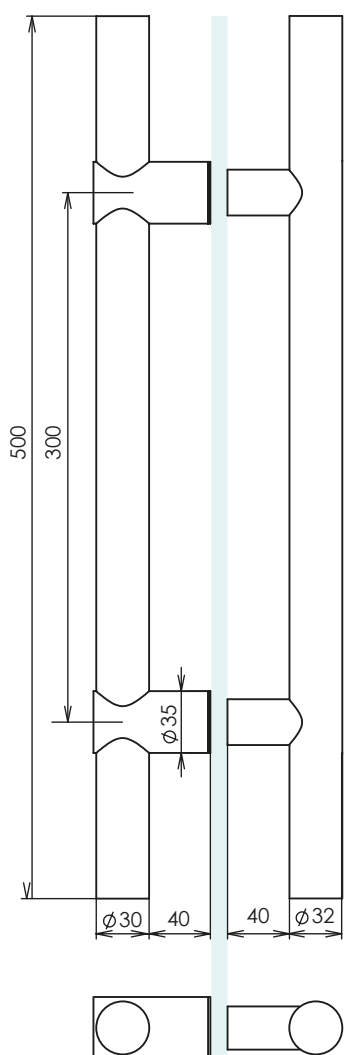

Příprava skla:

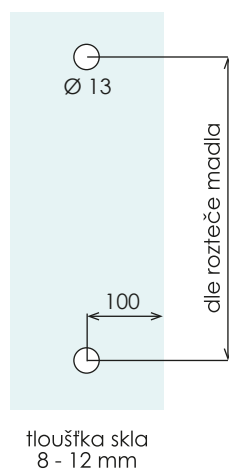

Varianty:

| Průměr | Rozteč | Celková délka |
|--------|--------|---------------|
| Ø 30   | 300    | 500           |

rozměry v mm  
Jiné rozměry nebo povrchové úpravy na dotaz.



madla ze dřeva (buk nebo dub)

## Madlo W1



### Madlo W1:

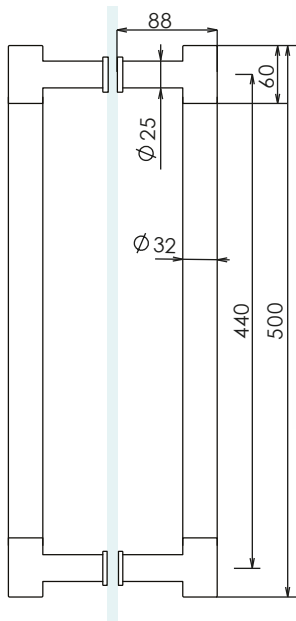

### Povrchové úpravy:



nerez brus    zlatý titan    černý chrom    nerez lesk

### Příprava skla:

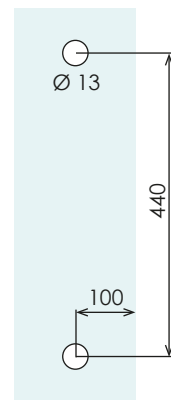

tloušťka skla  
8 - 12 mm

rozměry v mm  
Jiné rozměry nebo povrchové úpravy na dotaz.

madla ze dřeva (buk nebo dub)

## Madlo W2

### Madlo W2:

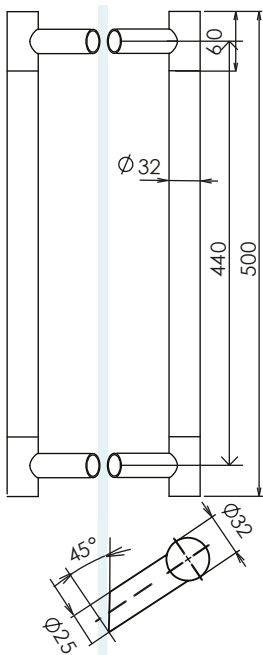

### Povrchové úpravy:



nerez brus    zlatý titan    černý chrom    nerez lesk

### Příprava skla:

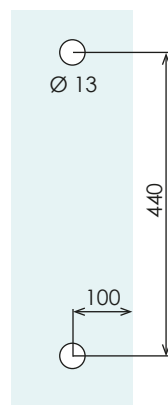

tloušťka skla  
8 - 12 mm

rozměry v mm  
Jiné rozměry nebo povrchové úpravy na dotaz.



# Madlo F1 Ø20, 20x20 nerezová madla



realizace: Glass Home CZ s.r.o.  
fotograf: Radek Koudela



## Madlo F1 Ø20 nebo 20x20 mm (450/600 nebo 600/800 mm)

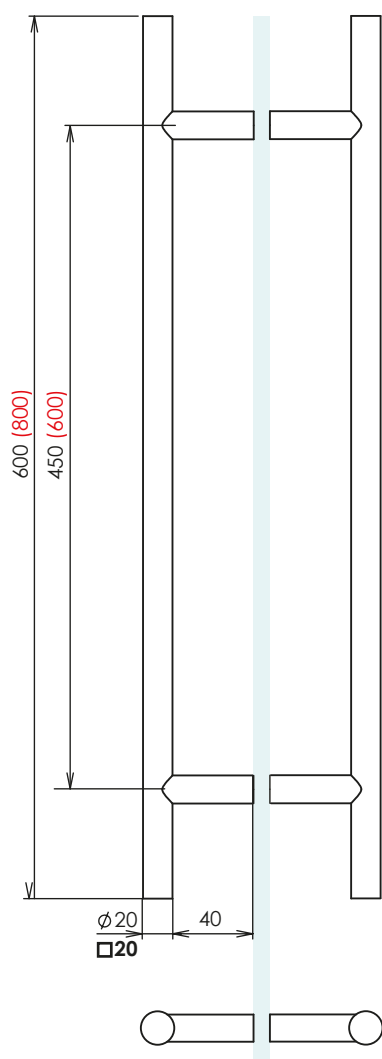

### Povrchové úpravy:



### Příprava skla:

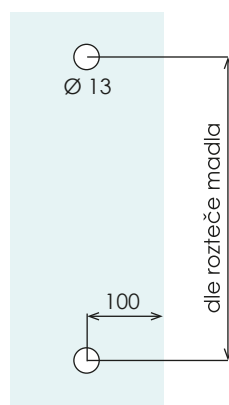

tloušťka skla  
8 - 12 mm

### Varianty:

| Průměr  | Rozteč | Celková délka |
|---------|--------|---------------|
| Ø 20    | 450    | 600           |
| Ø 20    | 600    | 800           |
| 20 x 20 | 450    | 600           |
| 20 x 20 | 600    | 800           |

rozměry v mm  
Jiné rozměry nebo povrchové úpravy na dotaz.



nerezová madla

# Madlo U Ø20, 20x20



realizace: ALTORESS s.r.o.

Madlo U Ø20 nebo 20x20 mm  
(300 nebo 600 mm)

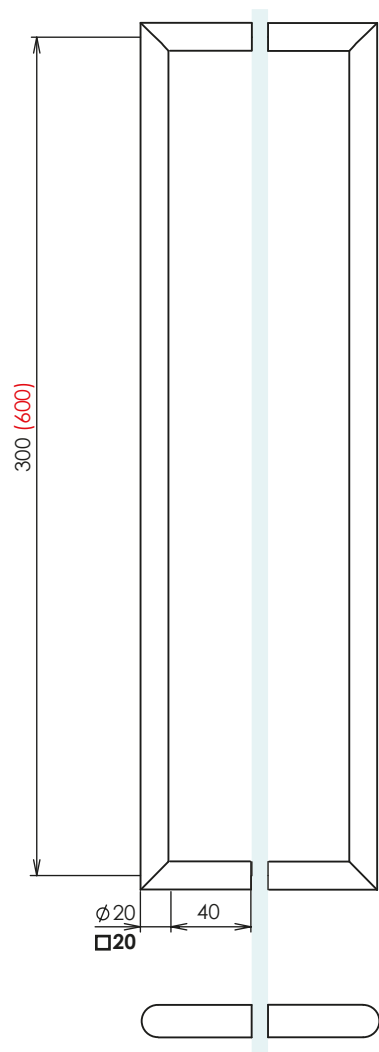

Povrchové úpravy:



Příprava skla:

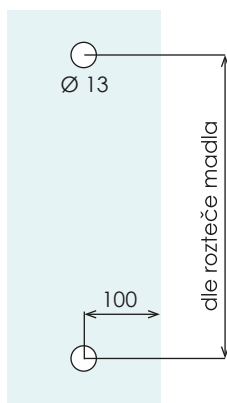

tloušťka skla  
8 - 12 mm

Varianty:

| Průměr  | Rozteč | Celková délka |
|---------|--------|---------------|
| Ø 20    | 300    | 320           |
| Ø 20    | 600    | 620           |
| 20 x 20 | 300    | 320           |
| 20 x 20 | 600    | 620           |

rozměry v mm  
Jiné rozměry nebo povrchové úpravy na dotaz.



# Madlo U Ø20, 20x20 s muší a záslepkou

nerezová madla

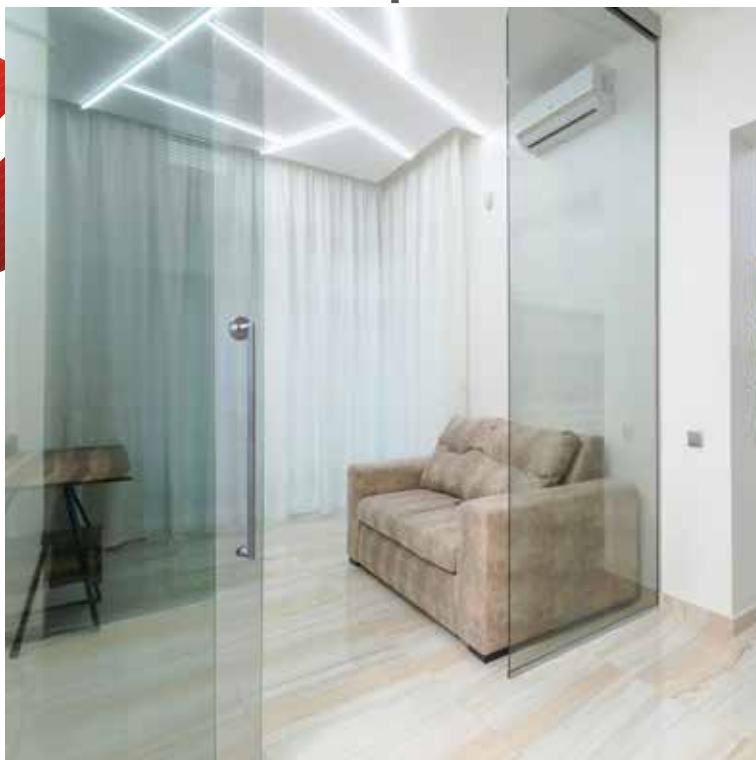

Madlo U Ø20 nebo 20x20 mm  
(300 nebo 600 mm)

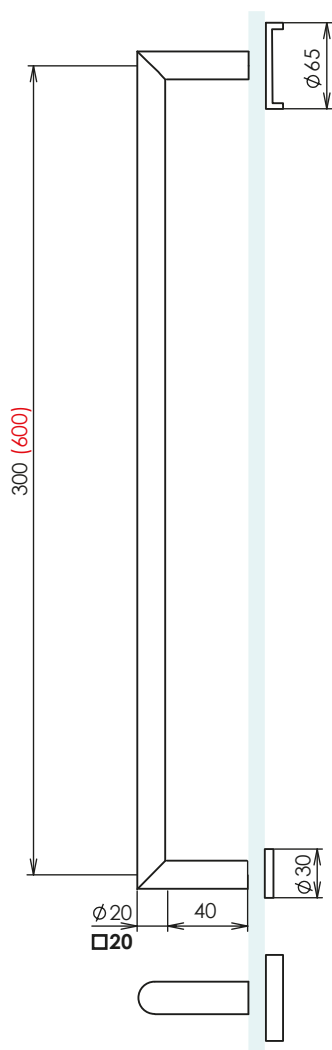

## Povrchové úpravy:



## Příprava skla:

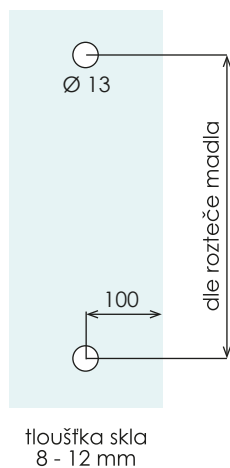

## Varianty:

| Průměr  | Rozteč | Celková délka |
|---------|--------|---------------|
| Ø 20    | 300    | 320           |
| Ø 20    | 600    | 620           |
| 20 x 20 | 300    | 320           |
| 20 x 20 | 600    | 620           |

rozměry v mm  
Jiné rozměry nebo povrchové úpravy na dotaz.



# Madlo F1 Ø20, 20x20 s muší a záslepkou

nerezová madla



Madlo F1 Ø20 nebo 20x20 mm  
(450/600 nebo 600/800 mm)

Povrchové úpravy:

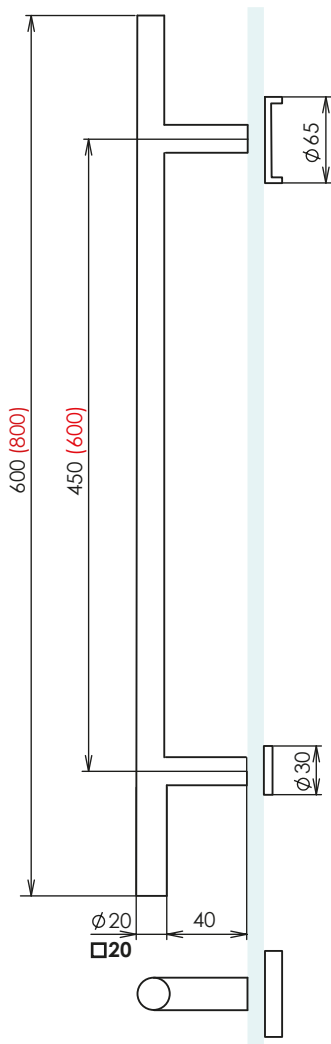

Příprava skla:

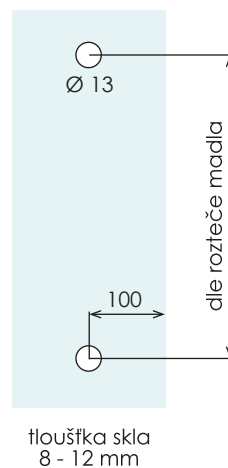

Varianty:

| Průměr  | Rozteč | Celková délka |
|---------|--------|---------------|
| Ø 20    | 450    | 600           |
| Ø 20    | 600    | 800           |
| 20 x 20 | 450    | 600           |
| 20 x 20 | 600    | 800           |

rozměry v mm  
Jiné rozměry nebo povrchové úpravy na dotaz.

# Madlo F1, F2, F3 a F4 nerezová madla



realizace: Woodyglass s.r.o.

## Madlo F1

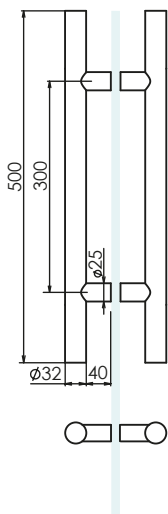

## Madlo F2

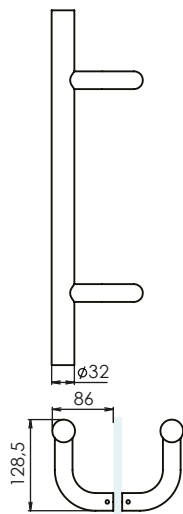

## Povrchové úpravy:



nerez brus



zlatý titan



černý chrom



nerez lesk

## Madlo F3

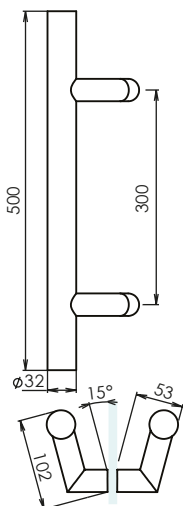

## Madlo F4

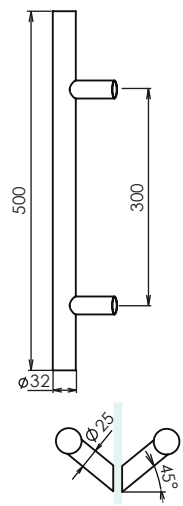

## Příprava skla:

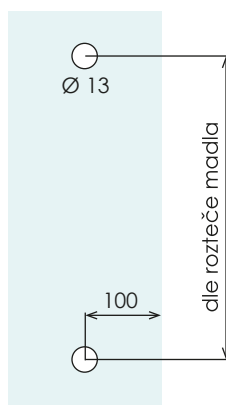

tloušťka skla  
8 - 12 mm

## Varianty:

| Typ | Rozteč | Celková délka |
|-----|--------|---------------|
| F1  | 300    | 500           |
| F2  | 300    | 500           |
| F3  | 300    | 500           |
| F4  | 300    | 500           |

rozměry v mm  
Jiné rozměry nebo povrchové úpravy na dotaz.



## Madlo B

### Povrchové úpravy:

### Příprava skla:

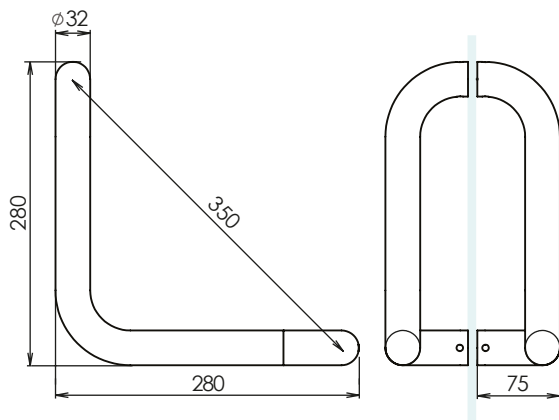

neruz brus

zlatý titan



černý chrom

neruz lesk

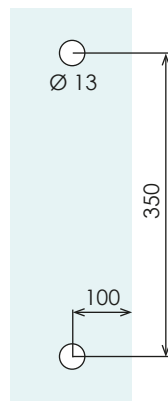

tloušťka skla  
8 - 12 mm



Jiné rozměry nebo povrchové úpravy na dotaz.

## Madlo C

### Povrchové úpravy:

### Příprava skla:

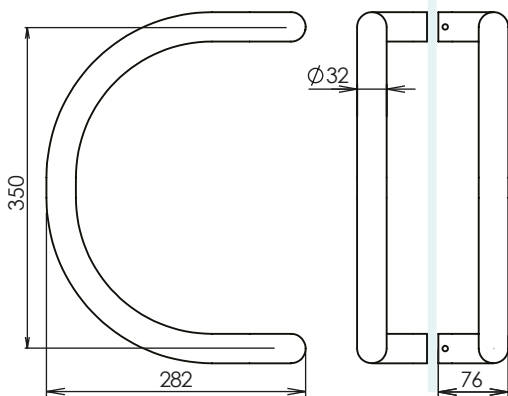

neruz brus

zlatý titan



černý chrom

neruz lesk

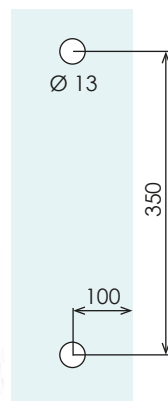

tloušťka skla  
8 - 12 mm

Jiné rozměry nebo povrchové úpravy na dotaz.

## Madlo G

### Povrchové úpravy:

### Příprava skla:

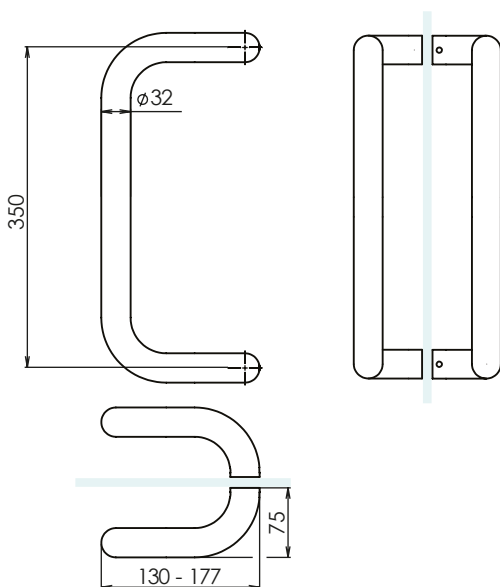

neruz brus

zlatý titan



černý chrom

neruz lesk

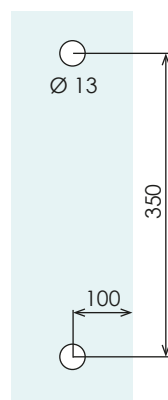

tloušťka skla  
8 - 12 mm

Jiné rozměry nebo povrchové úpravy na dotaz.

# Madlo U Ø 32 mm

nerezová madla



## Madlo U

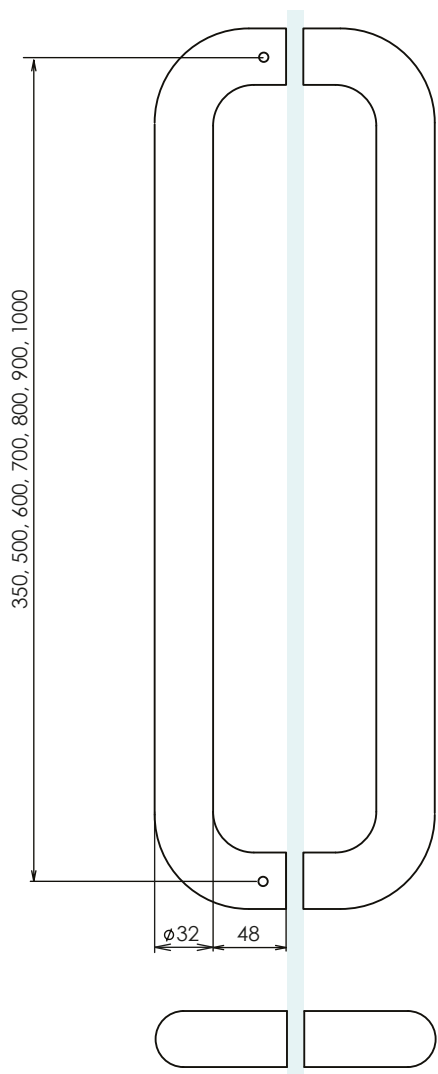

## Povrchové úpravy:



nerez brus



zlatý titan



černý chrom



nerez lesk

## Příprava skla:

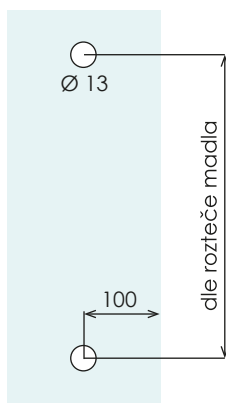

tloušťka skla  
8 - 12 mm

## Varianty:

| Typ   | Rozteč | Celková délka |
|-------|--------|---------------|
| U350  | 350    | 382           |
| U500  | 500    | 532           |
| U600  | 600    | 632           |
| U700  | 700    | 732           |
| U800  | 800    | 832           |
| U900  | 900    | 932           |
| U1000 | 1000   | 1032          |

rozměry v mm  
Jiné rozměry nebo povrchové úpravy na dotaz.



úchytky z křišťálového skla

# Úchytka Vali



## Úchytka Vali

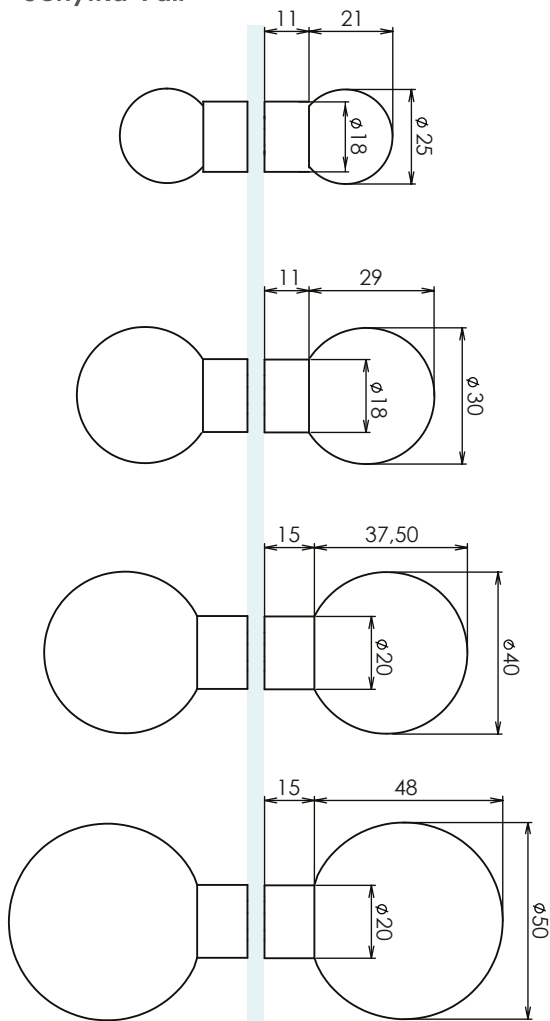

## Povrchové úpravy:



nerez brus



zlatý titan



černý chrom



nerez lesk

## Příprava skla:

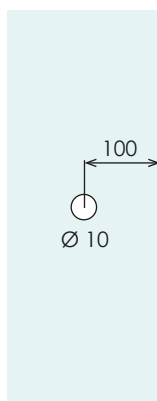

tloušťka skla  
8 - 12 mm

## Varianty:

| Rozměr skla | Rozměr soklu |
|-------------|--------------|
| Ø25         | Ø18 x 11     |
| Ø30         | Ø18 x 11     |
| Ø40         | Ø20 x 15     |
| Ø50         | Ø20 x 15     |

rozměry v mm  
Jiné rozměry nebo povrchové úpravy na dotaz.

# Úchytka Jula

úchytky z křišťálového skla



## Úchytka Jula

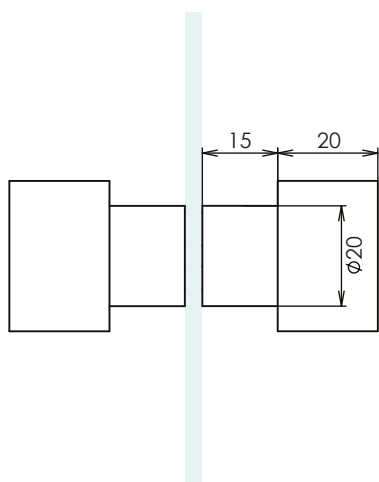

## Povrchové úpravy:



nerez brus



zlatý titan



černý chrom



nerez lesk

## Příprava skla:

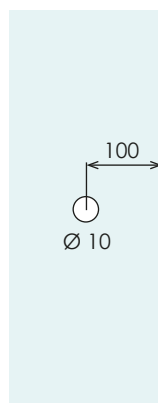
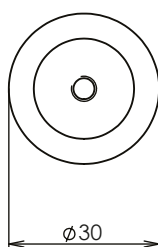

tloušťka skla  
8 - 12 mm

## Varianty:

| Rozměr skla | Rozměr soklu |
|-------------|--------------|
| Ø 30 x 20   | Ø 20 x 15    |

rozměry v mm  
Jiné rozměry nebo povrchové úpravy na dotaz.



úchytka z křišťálového skla

# Úchytka Galina



## Úchytka Galina

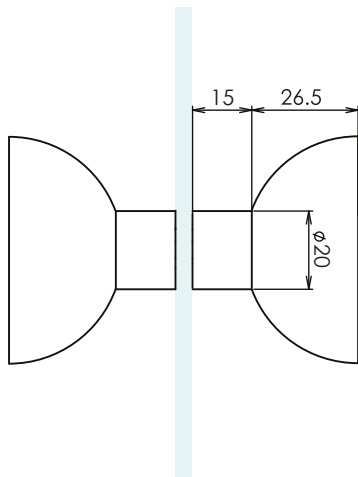

## Povrchové úpravy:



nerez brus



zlatý titan



černý chrom



nerez lesk

## Příprava skla:

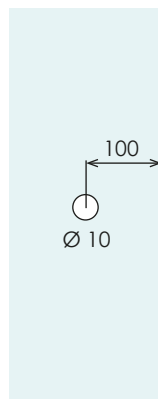
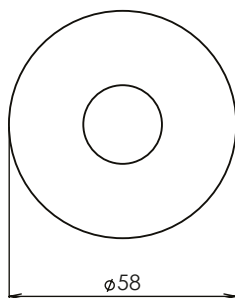

tloušťka skla  
8 - 12 mm

## Varianty:

| Rozměr skla | Rozměr soklu |
|-------------|--------------|
| Ø 58 x 26.5 | Ø 20 x 15    |

rozměry v mm  
Jiné rozměry nebo povrchové úpravy na dotaz.

# Úchytka Sascha

úchytky z křišťálového skla



## Úchytka Sascha

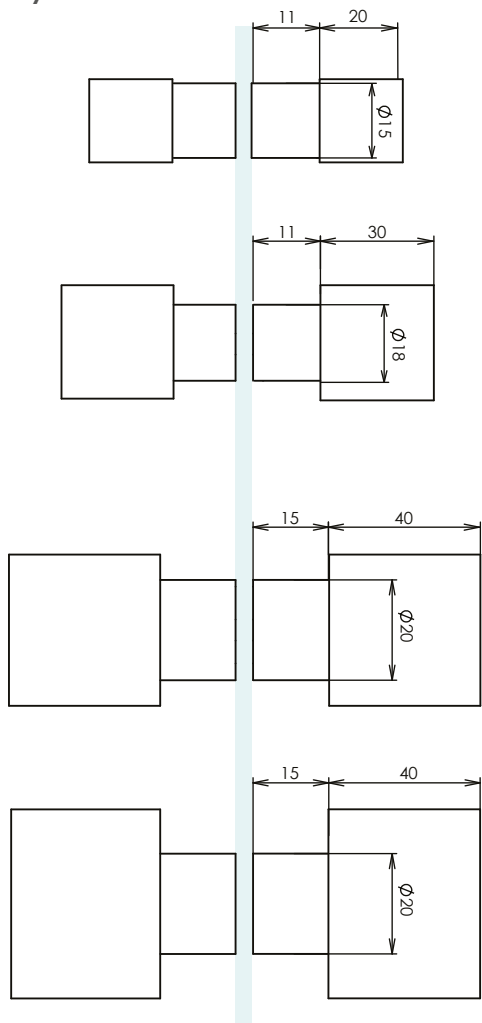

## Povrchové úpravy:



nerez brus

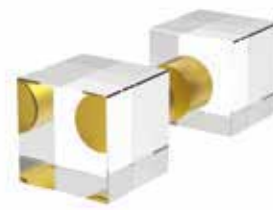

zlatý titan



černý chrom

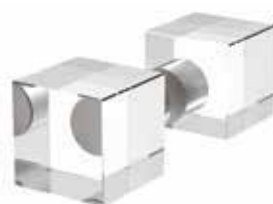

nerez lesk

## Příprava skla:

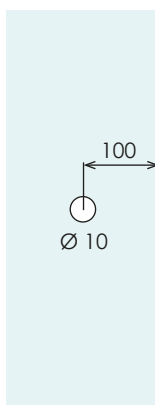

tloušťka skla  
8 - 12 mm

## Varianty:

| Rozměr skla  | Rozměr soklu |
|--------------|--------------|
| 20 x 20 x 20 | Ø15 x 11     |
| 30 x 30 x 30 | Ø18 x 11     |
| 40 x 40 x 40 | Ø20 x 15     |
| 50 x 50 x 40 | Ø20 x 15     |

rozměry v mm  
Jiné rozměry nebo povrchové úpravy na dotaz.



úchytka z křišťálového skla

# Úchytka Lena

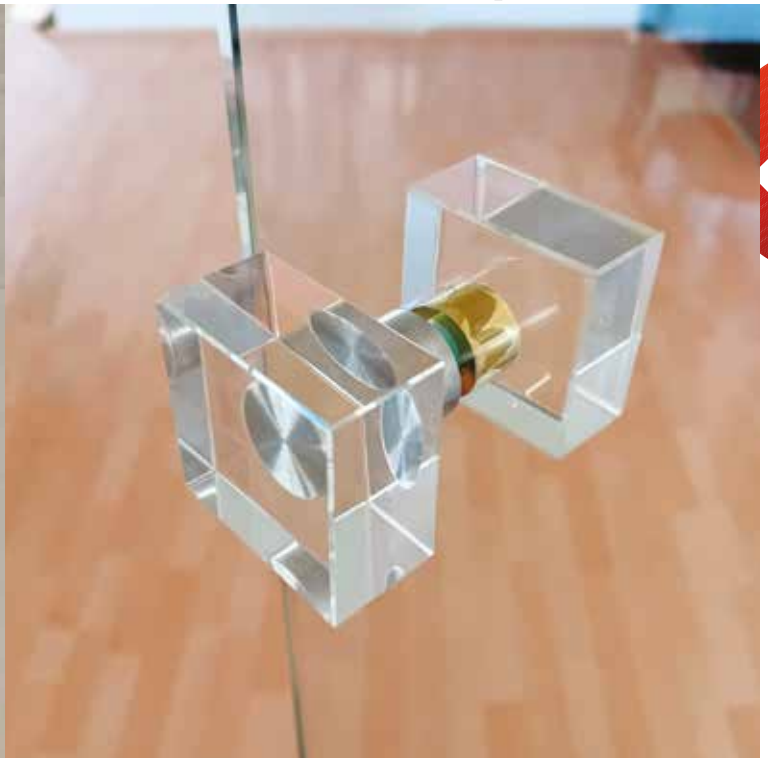

## Úchytka Lena

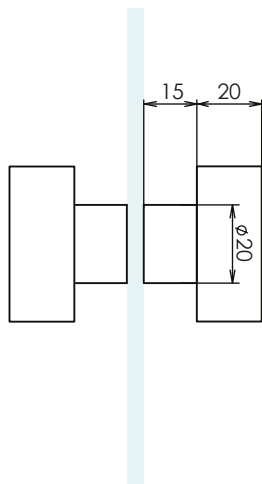

## Povrchové úpravy:



nerez brus

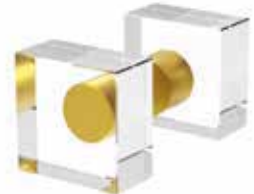

zlatý titan



černý chrom



nerez lesk

## Příprava skla:

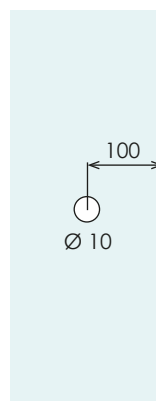
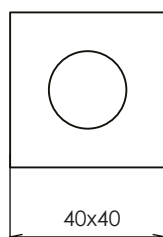

tloušťka skla  
8 - 12 mm

## Varianty:

| Rozměr skla | Rozměr soklu        |
|-------------|---------------------|
| 40x40x20    | $\phi 20 \times 15$ |

rozměry v mm  
Jiné rozměry nebo povrchové úpravy na dotaz.

# Úchytka Rita

úchytky z křišťálového skla



## Úchytka Rita

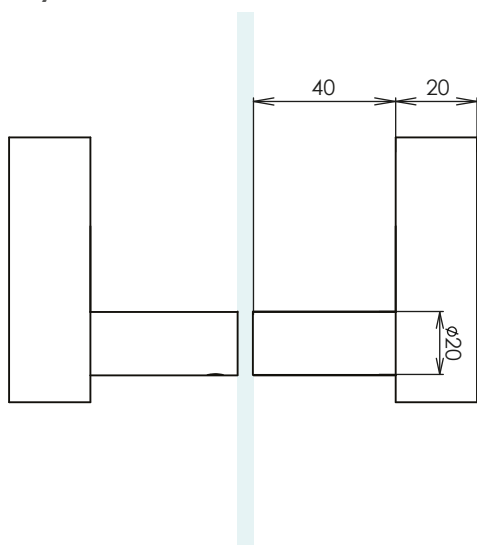

## Povrchové úpravy:



nerez brus



zlatý titan



černý chrom



nerez lesk

## Příprava skla:

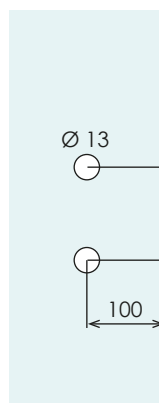
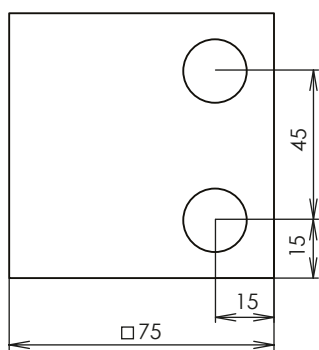

tloušťka skla  
8 - 12 mm

## Varianty:

| Rozměr skla  | Rozměr soklu |
|--------------|--------------|
| 75 x 75 x 20 | Ø20 x 40     |

rozměry v mm  
Jiné rozměry nebo povrchové úpravy na dotaz.



## Úchytka Judy

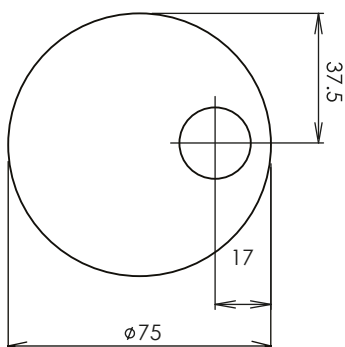
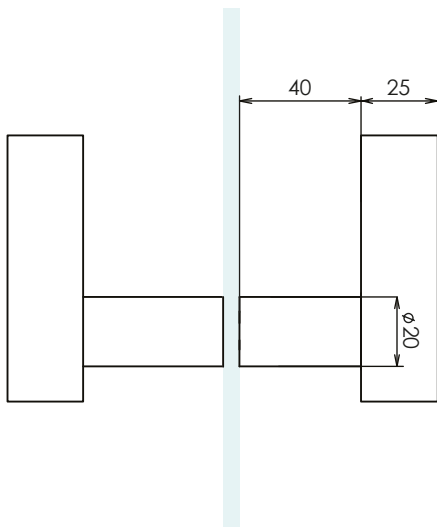

## Povrchové úpravy:



nerez brus



zlatý titan



černý chrom



nerez lesk

## Příprava skla:

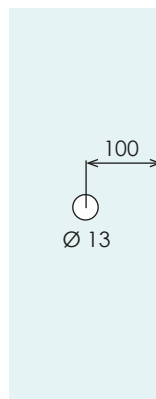

tloušťka skla  
8 - 12 mm

## Varianty:

| Rozměr skla         | Rozměr soklu        |
|---------------------|---------------------|
| $\phi 75 \times 25$ | $\phi 20 \times 40$ |

rozměry v mm  
Jiné rozměry nebo povrchové úpravy na dotaz.



# Kování pro celoskleněné dveře



160 x 65 mm



TGL35 S  
zámek

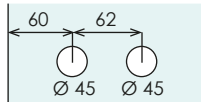

tloušťka skla 8 - 12 mm



TGL35 SBB  
zámek

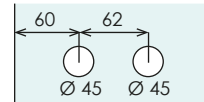

tloušťka skla 8 - 12 mm



TGL35 SNH  
zámek

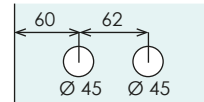

tloušťka skla 8 - 12 mm



TGS30S  
protikus k zámku  
TGL35S/SBB/SNH

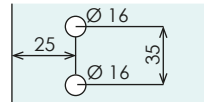

tloušťka skla 8 - 12 mm



2500 ES  
2D závěs

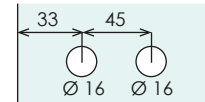

tloušťka skla 8 - 12 mm



CR311  
3D závěs

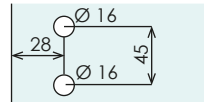

tloušťka skla 8 - 12 mm



TGL15 S  
zámek

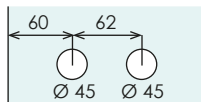

tloušťka skla 8 - 12 mm



TGL15 SBB  
zámek

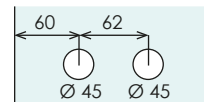

tloušťka skla 8 - 12 mm



TGL15 SNH  
zámek

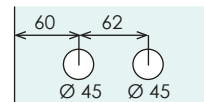

tloušťka skla 8 - 12 mm



TGS10S  
protikus k zámku  
TGL15S/SBB/SNH

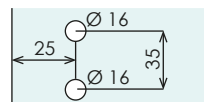

tloušťka skla 8 - 12 mm



2505 ES  
2D závěs

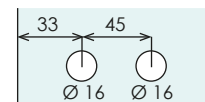

tloušťka skla 8 - 12 mm



CR312  
3D závěs

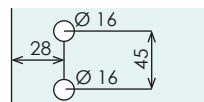

tloušťka skla 8 - 12 mm

magnetické



TGML35 S  
magnet. zámek

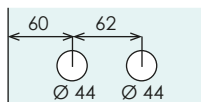

tloušťka skla 8 - 12 mm



TGS30S  
protikus k magn.  
zámku TGML35S

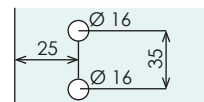

tloušťka skla 8 - 12 mm



FR-PML02  
protikus k magn.  
zámku

montáž  
kamkoliv do  
zárubně



TGML15 S  
magnet. zámek

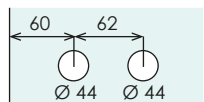

tloušťka skla 8 - 12 mm



TGS10S  
protikus k magn.  
zámku TGML15S

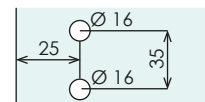

tloušťka skla 8 - 12 mm



FR-PML03  
protikus k magn.  
zámku

montáž  
na hranu  
zárubně

119 x 65 mm



TGL60 S  
zámek

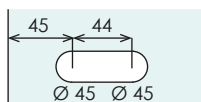

tloušťka skla 8 - 12 mm



TGL60 SNH  
zámek

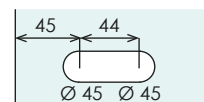

tloušťka skla 8 - 12 mm



TGS60S  
protikus k zámku  
TGL60S/SNH

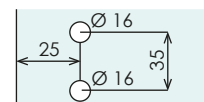

tloušťka skla 8 - 12 mm



Cylindrická  
vložka

FAB-8201 30/30  
MZLC01 25/30  
TGLC01 21/27



Cylindr. vložka  
s klíčem  
a motýlkem

TGLC01TC



Cylindr. vložka  
s motýlkem (WC)

TGLC01WC  
vnitřní otvírání

TGLC02WC  
vnější otvírání

## Povrchové úpravy:



nerez brus



zlatý titan



černý chrom



nerez lesk





# kliky z křišťálového skla k zámkům na sklo **Kliky Crystal Glass**



**Vilma**



**Ester**



**Nora**



**Zina**



**Gita**



**Brigita**



**Herta**



**Heda**



**Sava**



**Edita**



**Lada**



**Viki**

## Povrchové úpravy:



nerez brus



zlatý titan



černý chrom



nerez lesk

Všechny kliky jsou kompatibilní se zámky, panty a vložkami ze strany 22.



# Kliky MT a WS

kliky z nerezové oceli k zámkům na sklo



MT 00



MT 01



MT 02



MT 03



MT 04



MT 05



MT 06



MT 11



MT 12



MT 13



WS 00



WS 01

## Povrchové úpravy:



nerez brus



zlatý titan



černý chrom



nerez lesk

Všechny kliky jsou kompatibilní se zámky, panty a vložkami ze strany 22.





kliky z nerezové oceli k zámkům na sklo

# Kliky Wood, ME, MC



Nora raffir poplar burl



Nora ořešák černý



Sáva kudrnatá bříza



Heda ebiara



ME 01



ME 04



ME 08



ME 14



ME 17



ME 18



MC 00



MC 01

## Povrchové úpravy:



nerez brus



zlatý titan



černý chrom



nerez lesk

Všechny kliky jsou kompatibilní se zámky, panty a vložkami ze strany 22.



# Kliky ME light, Hunter, Techno Steel a koule MSK

kliky z nerezové oceli k zámkům na sklo



ME 14 light



ME 15 light



ME 16 light



Hunter 00



Hunter 01



Hunter 02



Techno Steel



MSK 01



MSK 08



MSK 09



MSK 09 vyosená



MSK 11

## Povrchové úpravy:



nerez brus



zlatý titan



černý chrom



nerez lesk

Všechny kliky jsou kompatibilní se zámky, panty a vložkami ze strany 22.



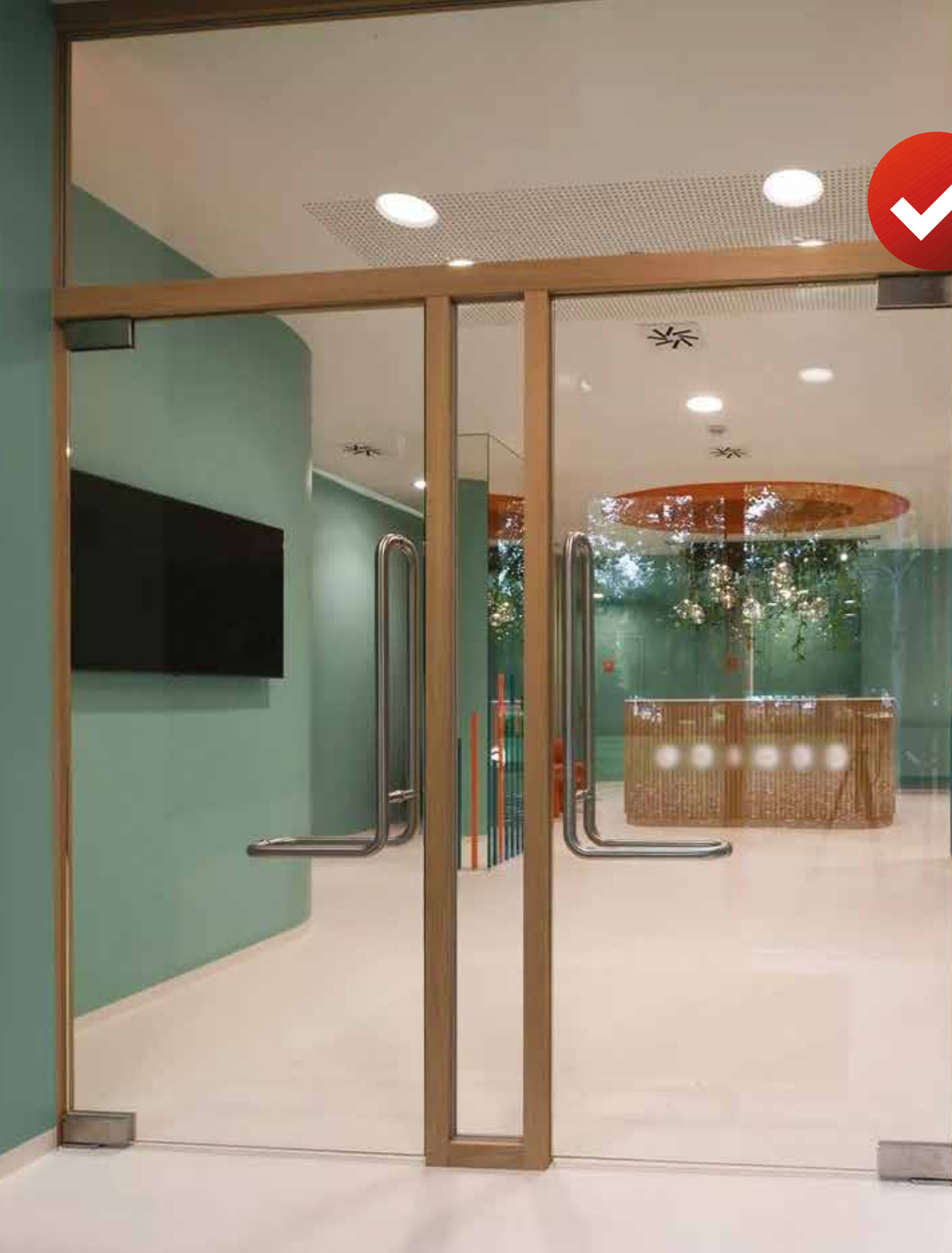

realizace: Woodyglass s.r.o.



KONTAKT:

Čegan, s.r.o., provoz Holar  
Husova 1693/35, 664 51 Šlapanice

mobil: +420 724 032 640  
mobil Morava: +420 776 549 991  
mobil Čechy: +420 778 750 748

e-mail: obchod@holar.cz  
www.holar.cz www.holar.biz www.piktograms.cz

